

## Product: RM-1600

Solatube was first to introduce a solar powered roof ventilator in Australia, and we've been cooling homes for over 20 years in the harshest climates throughout the continent.

Designed for longevity and using the highest quality components, Solatube ventilators have held Northern Territory's stringent cyclone rating compliance for over 15 years, and offer Australia's longest solar powered roof ventilator warranty. In combination with our tailored flashings to suit individual roof profiles and our Highest Performance Guarantee\* - it's easy to see why the Solatube RM-1600 is trusted by so many Australians.

It is well documented that a poorly ventilated roof can increase heating and cooling costs, contribute to dangerous mould and accelerate deterioration of insulation and structural components.

Temperatures inside a roof with inadequate ventilation can reach as high as 60°C. Heat trapped in the roof acts like a heat sink which can eventually penetrate insulation layers and radiate heat into the interior, making air conditioning units work harder and using more energy. Solatube solar roof ventilators will effectively reduce the heat load, and remove moisture and condensation trapped inside the roof.

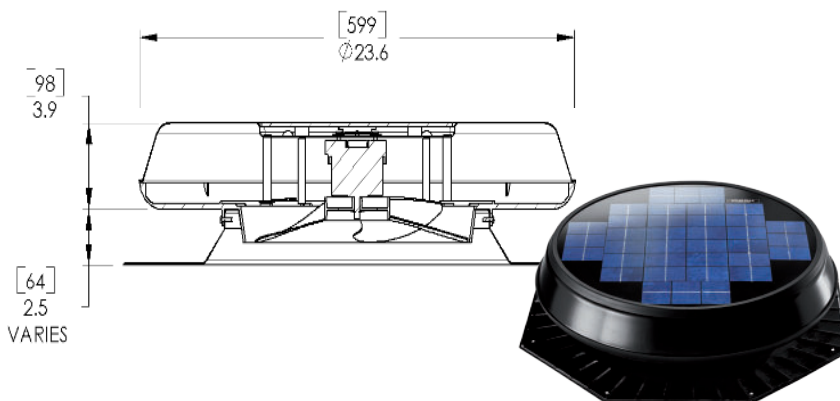

### TECHNICAL SPECIFICATIONS

 **Airflow:**  
970 m<sup>3</sup>/h  
NATA approved testing to ISO5801  
Highest Performance Guaranteed!\*

 **Motor:**  
Whisper quiet, brushless DC  
with double-shielded ball bearings

 **Solar panel type:**  
Advanced monocrystalline.  
High-impact resistant glass coating  
providing protection from hail, wind

 **Solar panel output:**  
22W

 **Fan:**  
5-wing, 300mm diameter canted  
polymeric fan blade designed for  
high airflow output and low noise.  
Corrosion resistant.

 **Sound rating:**  
51dB at 1 meter

 **Flashing:**  
Tailored roof flashing kits to suit specific  
roof profiles

 **Construction:**  
1mm thick e-coated steel main body  
with moulded plastic grille

 **Warranty:**  
5 year warranty on solar panel and motor.  
10 year warranty on all other components

### Manufacturer's Residential Quantity Recommendation

1 x RM1600\* for up to 250m<sup>2</sup> of roof area. For optimal performance position on northern side of roof.

\*calculated to meet a minimum of 5 recommended air exchanges, using a ceiling to ridge height of 1.8m

#### Additional units may be required if:

- extracting air from inside the home through ceiling vents
- roof pitch is over 25°
- overshadowing or southern aspect location

**Air intakes** – for every 50m<sup>2</sup> of roof area, minimum 0.035m<sup>2</sup> size vents

### \*HIGHEST PERFORMANCE GUARANTEE

Solatube Australia guarantees, that our product offers the highest airflow performance when tested to ISO 5801-2004 through a NATA (National Association of Testing Authorities) approved testing agency, of any similar products currently available in the market. If proven incorrect, Solatube Australia will pay for the customer's chosen product.

#### For more details, visit:

[www.solatube.com.au/highest-airflow-performance-guarantee-solar-star-rm1600-roof-ventilation/](http://www.solatube.com.au/highest-airflow-performance-guarantee-solar-star-rm1600-roof-ventilation/)